

## Contact Details

Before using the product, please check the guide pages at the front of this catalog.

Internet

<https://www.daikinpmc.com/en/>

For latest information, PDF catalogs and operation manuals

# 03 Series Stacking Type Port P Flow Control Valves

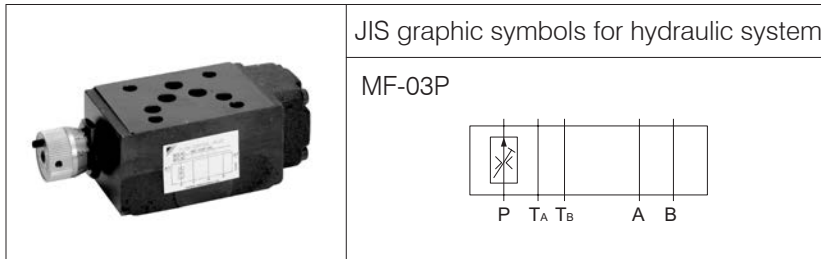

JIS graphic symbols for hydraulic system

MF-03P

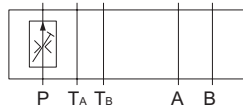

## Nomenclature

※ - MF - 03 P - 45

1 2 3 4 5

### 1 Applicable fluid code

No designation: Petroleum-based hydraulic fluid,  
water-glycol hydraulic fluid  
F: Phosphate ester hydraulic fluid

### 2 Model No.

MF: Modular stacking type flow control valve

### 3 Nominal diameter

03:  $\frac{3}{8}$

### 4 Control port

P: Port P

### 5 Design No.

(The design No. is subject to change)

Note: Contact DAIKIN separately for the delivery term of the products that accept phosphate ester hydraulic fluids.

## Specifications

Model code	Maximum operating pressure MPa {kgf/cm <sup>2</sup> }	Maximum flow rate L/min	Control flow rate *1 L/min		Mass kg
			(1)	(2)	
MF-03P-45	25 {250}	60	0.3 to 60	0.5 to 60	3.1

Note: \*1 Control flow rate (1) Pressure difference between the inlet and outlet ports to be 7 MPa {70 kgf/cm<sup>2</sup>} maximum  
(2) Pressure difference between the inlet and outlet ports to be 25 MPa {250 kgf/cm<sup>2</sup>} maximum

## Handling

- To ensure good pressure compensation performance, maintain a pressure difference of 1 MPa {10 kgf/cm<sup>2</sup>} minimum between the inlet and outlet ports.
- The flow rate will not be zero even if the flow rate adjusting handle is fully tightened.

## Performance curves (viscosity: 32 mm<sup>2</sup>/s {cSt})

Pressure - Flow rate characteristics

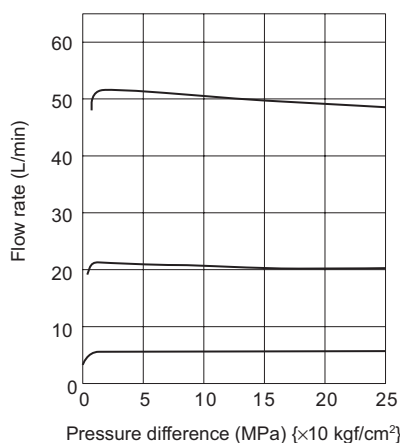

Fluid temperature - Flow rate characteristics

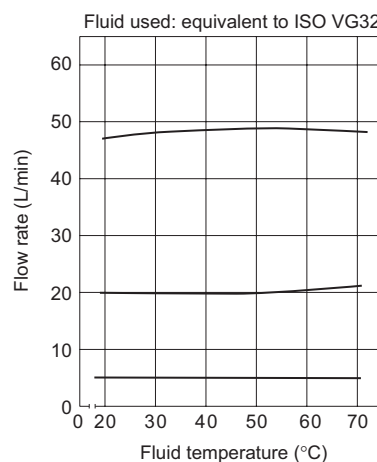

Handle revolution - Flow rate characteristics

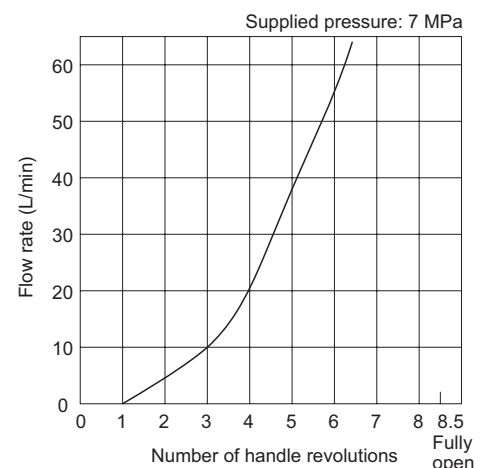

## Contact Details

Before using the product, please check the guide pages at the front of this catalog.

Internet

<https://www.daikinpmc.com/en/>

For latest information, PDF catalogs and operation manuals

## External dimension diagram

MF-03P

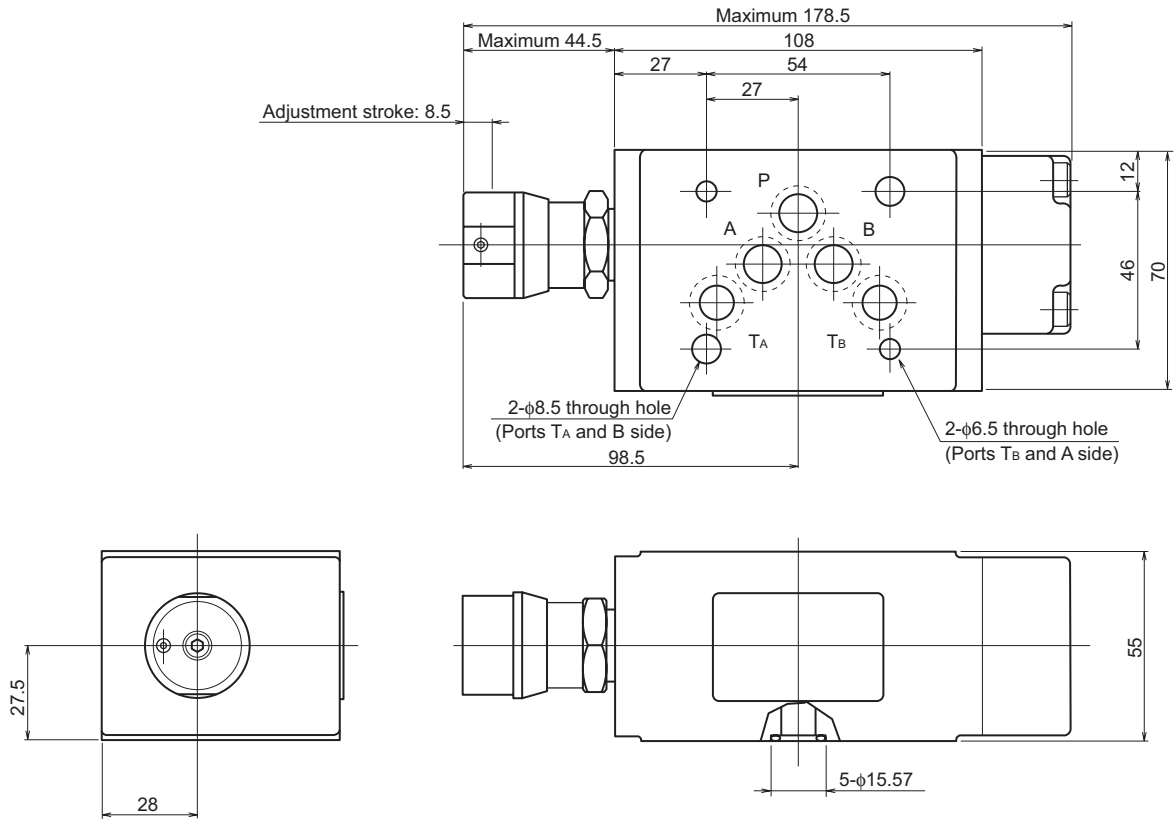

## Sectional structural diagram

MF-03P

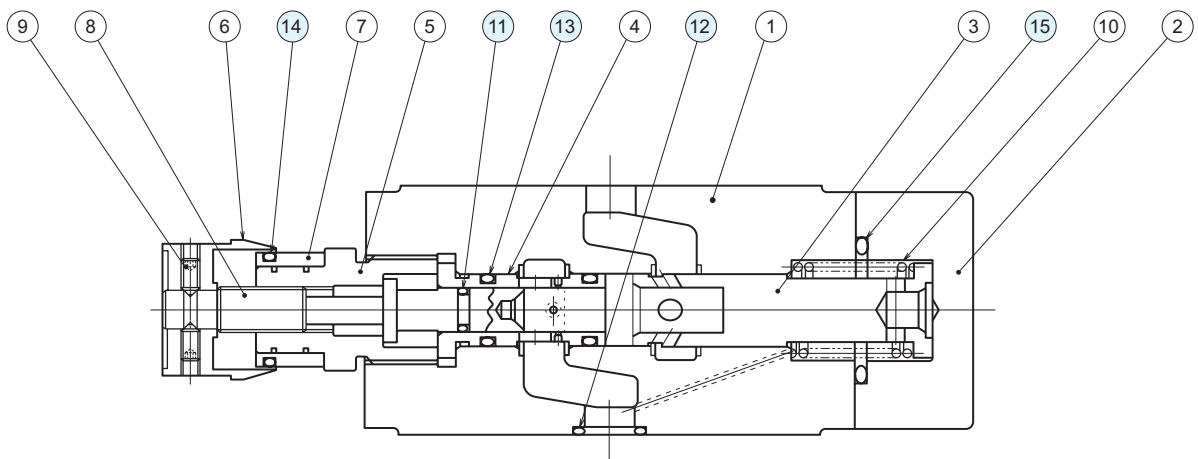

Sealing part table

Part No.	Name	Quantity	Part specifications
11	O-ring	1	JIS B 2401 1A P7
12	O-ring	5	AS568-014 (NBR, Hs90)
13	O-ring	2	JIS B 2401 1B P12
14	O-ring	1	JIS B 2401 1A P21
15	O-ring	1	JIS B 2401 1B P26